



Ebike operation instruction

This is a precision instruction ,please make sure you read this carefully before you try your first ride.
If you doubt about any information inside this insturction,please contact us or your local distributor .

1685 Ingleton Ave, Burnaby, BC V5C 3V6

+1 (604)-423-3381 | +1 (800)-694-9581

info@ebikebc.com | <https://ebikebc.com>

Meet your Ebike

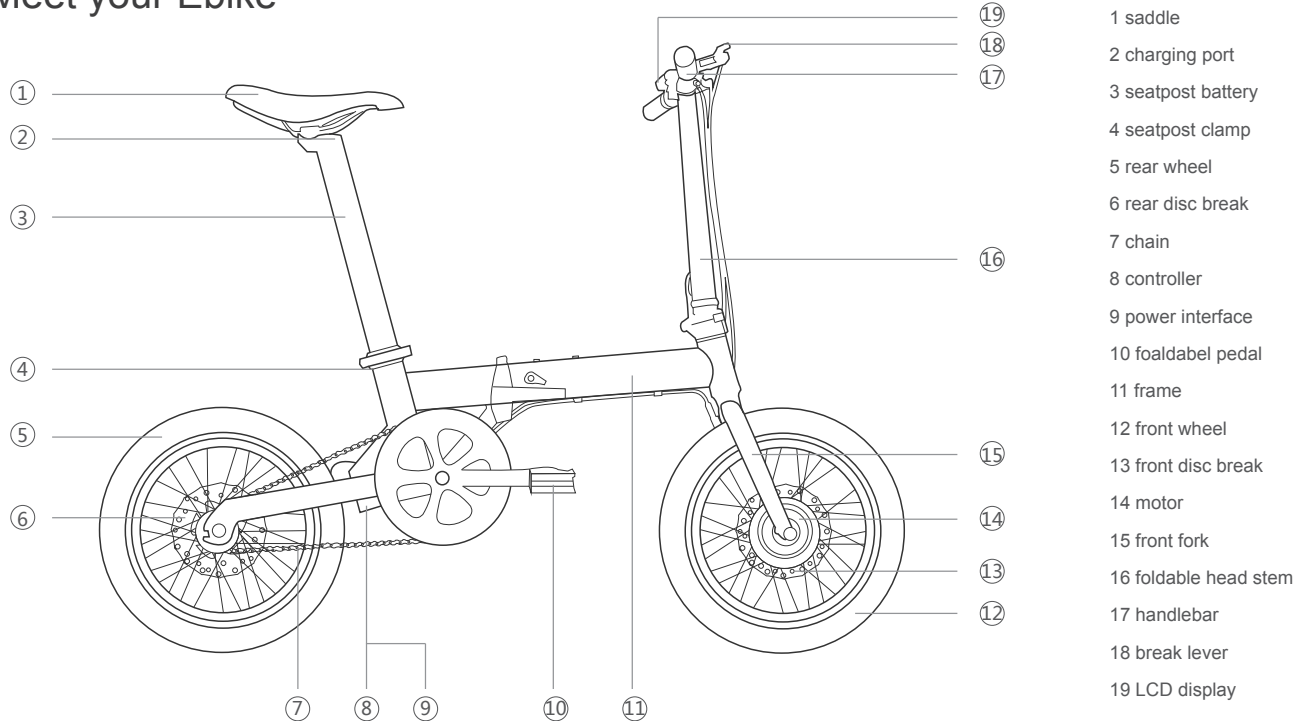

Parameter

Product name: Ebike

Model name: 16" folding ebike

Size: 1320*580*980mm

Folded size: 710*360*630mm

Wheel base: 930mm

Net weight: 14kg

Range: PAS>25KM Standard

load: 100KG

Top speed: <25KM/H Charge

time: 3 Hs

Battery type: Lithium-ion

Battery capacity: 36V7.8Ah

Noise : ≤62db(A)

Motor : 250W brushless geared DC motor

Rated output power: 250W

Motor efficiency: ≥80%

Rated RPM: 300r/min

Rated voltage: 36V

Max torque: 40N.m

Overcurrent protection: 12±1A

Low-voltage protection: 30±1V

Kwh: ≤1.2Kw.h

Ride system: 5 classes PAS+cruise

Tire diameter: 16inch

Frame: 16 inch 6061 Al-Alloy foldabel

Front fork: 16 inch inch 6061 Al-Alloy

Break: 160mm disc break

Rim: 16 inch Al-Alloy 13G36H

Tire: Kenda 16*2.125

Chain wheel: Prowheel 52T

Fly wheel: 14T

Rear hub: Sigma Al-Alloy

Chian: KMC

Handle bar:EVA

Display: Kunteng LCD

Controller: Kunteng sine wave FOC

Break lever: Al-Alloy ebike lever

Saddle: KNUS

Pedal: foldabel pedal

Fold your Ebike

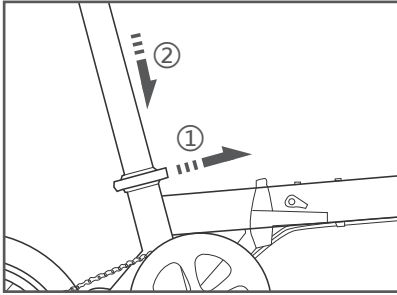

1. grab the seat post (important). loose the clamp.
2. Push the seatpost till the ground slowly, tight the seatpost clamp.

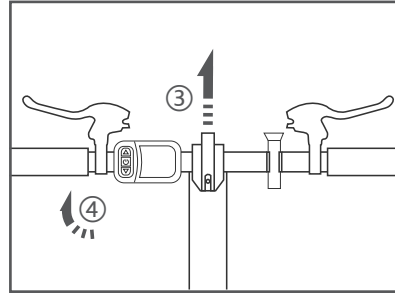

3. loose the handle bar clamp.
4. turn the handlebar clockwise till vertical, tight the clamp.

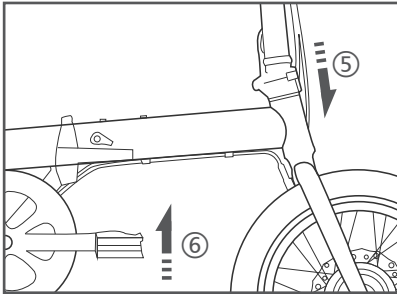

5. release the lock clamp, fold the head tube.
6. fold the pedal by pushing it level.

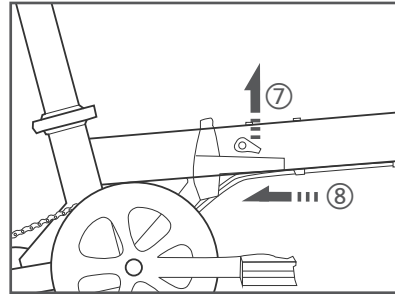

7. release the safety cap.
8. pull the lock bar, fold the main tube.

KT-LCD5 eBike Display User Manual

V1.0

Dear customer, please read this manual before you use KT-LCD5 instrument. The manual will guide you use the instrument correctly to achieve a variety of vehicle control and vehicle status display.

Functions and Display

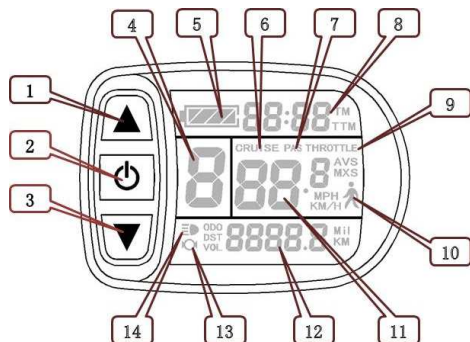

1		UP Button	11	Km/H	Riding speed(metric)
2		SW Button		MPH	Riding speed (imperial)
3		DOWN Button		MXS	MAX speed
4	ASSIST	Pas level	12	AVS	Average speed
5		Battery capacity indicator		Km	Distance(metric)
6	CRUISE	Cruise function		Mil	Distance (imperial)
7	PAS	Power-assisted function		DST	Trip distance
8	TM	Single trip time		ODO	Total distance
	TTM	Total trip time		VOL	Battery voltage
9	THROTTLE	Throttle display			The brake display
10		6Km/H push power assist	14		Backlight and headlights

Operation

1. ON/OFF

Hold button long to turn on the power, and hold long for a second time to turn off the power. When the motor stops driving and when the e-bike is not used for a consecutive 5 minutes, it will automatically shut down and turn off the motor power supply.

2. Display 1



Hold button to start up and enter display 1.

2.1 Turn on backlight and headlights

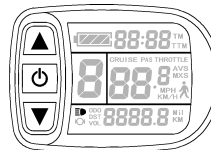

Hold long to turn on backlight and headlights (the controller should have headlight drive output function); hold long again to turn off the backlight and headlights.

2.2 Assist ratio gear (ASSIST) switch

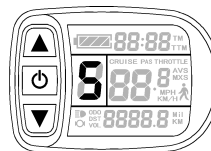

Hold or shortly to switch 1-5 file gear. Gear 1 is for the minimum power, gear 5 is for the highest power. Each startup will automatically restore the gear shutdown last time(the user can set randomly). Gear 0 is without booster function.

2.3 THROTTLE display

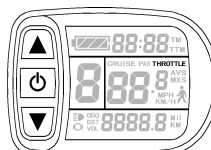

Turn on throttle, THROTTLE display.

2.4 Cruise function

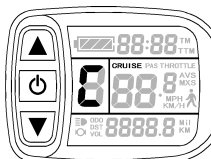

After the cruise function is turned on, the trip riding speed is greater than 7 km/ h, hold long and enter cruise, the CRUISE lit. Brake or hold any button to cancel.

2.5 Display and delete of single Data



After power on for 5 seconds, hold ▲ and ▼ at the same time, single trip riding time (TM) and single trip distance (DST) flash, hold ⏻ button shortly, the content of both is cleared. If failed holding the button within 5 seconds, it will automatically return the display interface after 5 seconds, original content is preserved.

3. Display 2



Hold ⏻ button shortly in display 1 to enter display 2. In the riding mode after 5 seconds, display 2 automatically returns to display 1.

4. Display 3



Hold ⏻ button shortly in display 2 to enter display 3. In the riding condition, five seconds later, a single maximum speed (MXS) display automatically returns to the real riding speed (Km/H).

5. In display 3, hold ⏻ button shortly (SW), and the display will re-enter display 1.
6. Hold ⏻ button to turn off the display and the power supply of controller.
7. Automatically prompt interface

7.1 Error Code Display

Error Code	Definition
01__info	Throttle Abnormality
03__info	Motor hall signal Abnormality
06__info	Motor or controller has short circuit Abnormality

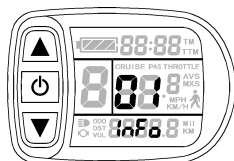

Electronic control system failure will display (flashing) fault code. Once the fault was removed, it automatically exits from the fault code display interface.

General Project Setting

1. Set maximum riding speed



After power on for 5 seconds, hold ▲ and ▼ at the same time, and maximum riding speed Km/H and MXS flash, ▲ or ▼ shortly to hold the maximum riding speed (default 25Km/H). ⏻ button shortly and Hold go to the next parameter settings.

DO NOT SET ABOVE LOCAL SPEED LIMIT FOR THIS DEVICE.

2. Wheel diameter setting

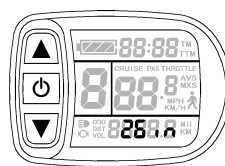

The wheel diameter will be set after finishing setting the maximum riding speed, wheel diameter specifications flashes. Hold ▲ or ▼ shortly to set the specifications of wheel diameter. Select the range 6,8,10,12,14,16,18,20,22, 24,26,700c and 28 inches. Hold ⏻ button shortly and go to the next parameter settings. **FIREFLY WHEEL IS SET FOR 12" WHEEL DIAMETER.**

3. Set the metric units

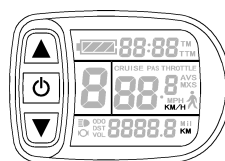

The metric units will be set after finishing setting wheel diameter, Km/H and Km flash. Hold ▲ or ▼ shortly and select the three metric units of speed, mileage, and ambient temperature in synchronization.

Display	Metric	Imperial
Riding speed	Km/H	MPH
Total distance	Km	Mil

4. Km/H and Km stop flash after metric unit setting is completed. Hold ⏻ button shortly again to re-enter the maximum riding speed setting interface; or hold ⏻ button long to exit from setting environment of routine projects and save the setting values, returning to display 1.
5. Exit from routine project setting

All three routine project settings can exit from the setting environment and return to the display if hold ⏻ button long after each setting is completed, meanwhile the setting values are saved.

Under each setting interface, if the button failed holding for more than 1 minute, it will automatically return to display 1, and the setting value is invalid.

Outline Drawings and Dimensions

1. Dimensions of main instrument body

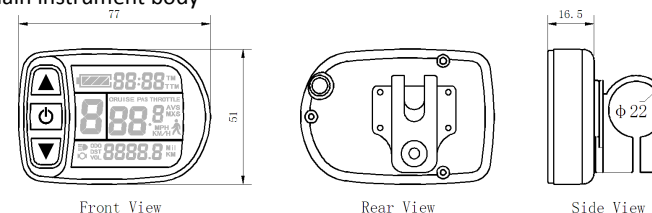

2. Wiring diagram

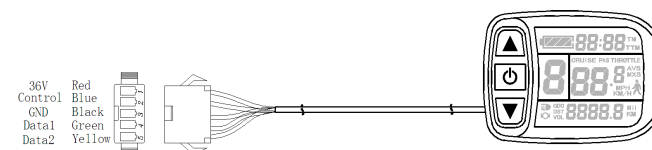

Charge your Ebike

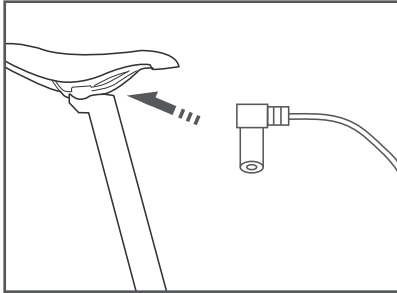

Charging port is right beneath the saddle, covered by a rubber dust-free cover, uncover it, plug the charger into the port; cover the port again when charged.

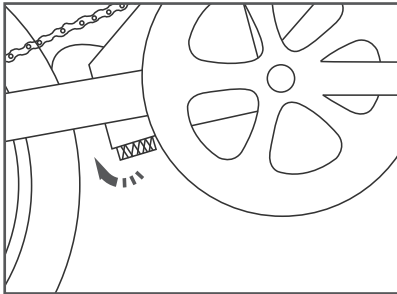

If you want to charge your battery separately, roll out the power port, release the seatpost clamp, pull out the seatpost battery, then repeat the steps above.

Accessory list

1 front mud fender

2 rear mud fender

3 reflectors

4 ring

5 lamp

Please mount accessories according to your needs.

Attention

Battery & Charge

- 1.Red indicator on the charger means charging,when it turns green ,please stop charging your battery;
- 2.Do not expose to temperature $-20^{\circ}\text{C} < \text{ or } > 35^{\circ}\text{C}$, Fully charge the battery and store separately if not use for over 30 days.Fully charge it every 90days,or the battery may self-discharge and be damaged.This damage is not covered by the Limited Warranty;
- 3.Never expose your battery to damp environment or soak into water,never short circuit the battery terminals, This damage is not covered by the Limited Warranty;
- 4.Charge with the original charger only;
- 5.Do not disassemble/punch battery pack.Do not place it in fire or drop from high ,Avoid contacting with contacts;
- 6.Turn off Ebike' s power before charge it.Plug the charge port first then the AC plug;
- 7.Do not cover any items on the charger during charging;
- 8.Pull out charge port before the AC plug;
- 9.Please keep battery outreach from children.
- 10.The capacity of Li-battery will decrease when $-10^{\circ}\text{C} <$;
- 11.Recycle or dispose of in accordance with local regulations.

Ride & Maintance

- 1.Must with your helmet on and follow the local laws and regulations ;
- 2.Read this instruction carefully before riding a Ebike ;
3. Start your ride with the 3rd PAS class ;
4. Keep the lamp on at night ;
5. Fully check break system ,tire pressure ,and battery remain before riding ;
6. PLEASE do take front break FIRST ;
7. Do not intense riding ;
8. Do not ride into water over 15cm ;
9. Replace the quick-wear parts(like break pad)in time ;
10. Put the Bike in 0 pedal assist as you are walking it for safety concerns.
11. Juveniles, Pregnant, Intoxicated are not allowed to ride Ebike ;
12. Keep your Ebike away from damp, high temperature or corrosive environment ;
13. Keep your Ebike away from sun-scorched and rain-drenched ;
14. Check screws ,chain and other parts regularly.
15. Terms & Conditions:
<https://ebikebc.com/support/terms-and-conditions/>